

MOBILE FOAM TROLLEY UNIT

SS304, 150 LTRS CAPACITY



Mobile foam trolley units are mobile foam compound tanks fitted with foam branches and inductors, and having arrangement to carry hoses. Ideal for quick mobilization of foam equipment and application of foam, especially for areas such as Oil depots, Paint/ Solvent storage areas, Petrochemical complexes, etc.

Brief Description : AAAG Mobile Foam Trolley Unit MFT150-S, consisting of SS304 tank (150 Ltrs capacity), mounted on sturdy chassis/frame for easy maneuverability. Arrangements provided to mount low/medium expansion Foam Branch and matching Inline Inductor of 225/450 lpm capacity, as well as two nos. 15 Mtrs long Fire fighting Delivery hoses.

1.0 GENERAL DATA

1.1	Make	AAAG
1.2	Model	MFT150-S
1.3	Capacity	150 Ltrs
1.4	Foam Equipment	Foam Branch (225/450 lpm) with matching Inline Inductor
1.5	Reference	--

2.0 MATERIAL OF CONSTRUCTION

2.1	Tank	SS 304
2.2	Chassis frame	M.S. / SS 304
2.3	Wheels	Solid polymer
2.4	Hose basket	SS 304
2.5	Foam Branch	SS304
2.6	Inline Inductor	SS304

3.0 TESTING AND QUALITY CONTROL

3.1	Performance Requirements	Easy maneuverability of Trolley unit. Flow test as per branch/inductor capacity.
3.2	Documentation	Internal inspection report, supplier's certificates, approved laboratory test certificates

4.0 OPERATIONAL/ TECHNICAL DATA

4.1	Working pressure (for foam eqpt)	7 to 10 Kg/cm ²
4.2	Branch/ Inline Inductor	FB 5 (225 lpm at 7 kg/cm ²) & matching Inline Inductor or FB 10 (450 lpm at 7 kg/cm ²) & matching Inline Inductor.
4.3	Hoses	RRL or Synthetic Hoses, 15 Mtrs length (2 Nos).

5.0 FINISH

5.1	Tank	Painted or Natural finish
5.2	Branch/ Inline Inductor	Painted Fire Red Color IS: 5 Shade No 536
5.3	Frame	Painted Black colour

6.0 APPROVALS & MARKING

6.1	Approvals	--
6.2	Marking on Nozzle	AAAG/ Year of Mfg./ Capacity/ SL. No

7.0 WARRANTY

7.1	Warranty & Guarantee	12 Months from the date of supply
-----	----------------------	-----------------------------------

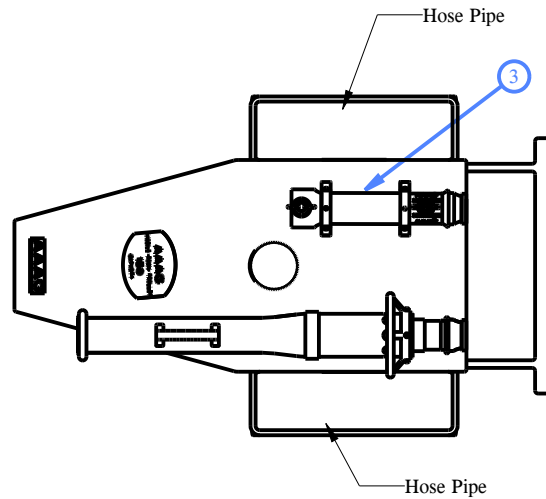
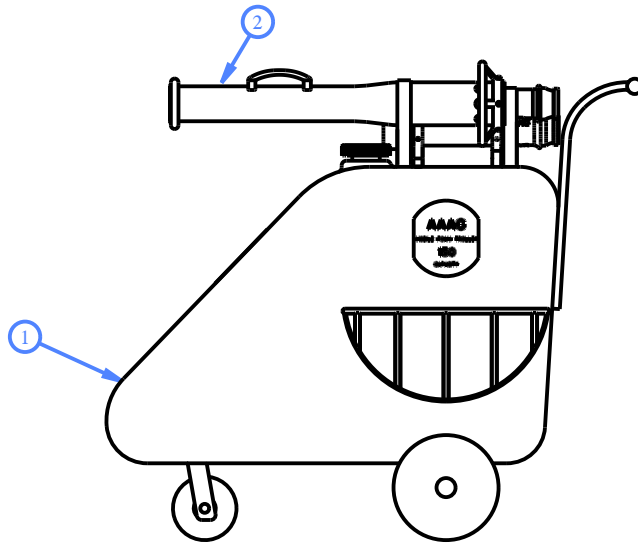

1	Tank	SS 304
2	Foam Branch Pipe	SS 304
3	Inline Inductor	SS 304
NO.	DESCRIPTION	MATERIAL
PART LIST		



Shah Bhogilal Jethalal & Bros.

AHMEDABAD

TITLE :

Mobile Foam Unit, 150 Ltrs Capacity,
SS 304 Body, Conventional Design

SCALE	DRAWING NO:	SHEET	REV.
N.T.S	S270-150BJ	1 OF 1	0