

ADAPTOR

GUNMETAL, 100 mm, FEMALE ROUND THREADS x FLANGED

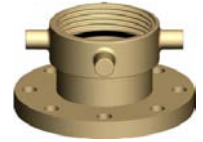

Adaptors allow connection of delivery or suction hoses to different fittings/equipment, which have a dissimilar connecting arrangement, e.g. connecting hoses to equipment having threaded connections, connecting instantaneous hose couplings to flanged equipment, connecting hoses having similar couplings, or hoses of two different sizes, etc.

Brief Description : AAAG Female Round Thread (100 mm) x Flanged (100 mm, ANSI B 16.5 150# or equivalent) Adaptor, made of Gunmetal, suitable for use with Firefighting equipment/systems having matching flange. Female Round Threads shall be matching to standard Male Round threads (100 mm size).

1.0 GENERAL DATA

1.1	Make	AAAG
1.2	Size	100 mm
1.3	Inlet	Flanged (100 mm, ANSI B 16.5 150# or equivalent)
1.4	Outlet	Female Round Thread (100 mm)
1.5	Material of Construction	Gunmetal
1.6	Reference	--

2.0 MATERIAL OF CONSTRUCTION

2.1	Adaptor	Gunmetal, IS:318 LTB-2
-----	---------	------------------------

3.0 TESTING AND QUALITY CONTROL

3.1	Dimensional check	See drawing below
3.2	Hydrostatic Pressure Test	21 kgf/cm ² for 2.5 minutes
3.3	Documentation	Internal inspection report, supplier's certificates, approved laboratory test certificates

4.0 OPERATIONAL/ TECHNICAL DATA

4.1	Working Pressure Range	upto 14 Kgf/cm ²
4.2	Weight (approx.)	9.5 Kgs. (approx)

5.0 FINISH

5.1	Adaptor	Polished
-----	---------	----------

6.0 APPROVALS & MARKING

6.1	Approvals	--
6.2	Marking	AAAG/ Year of Mfg./SI No

7.0 WARRANTY

7.1	Warranty & Guarantee	12 Months from the date of supply
-----	----------------------	-----------------------------------

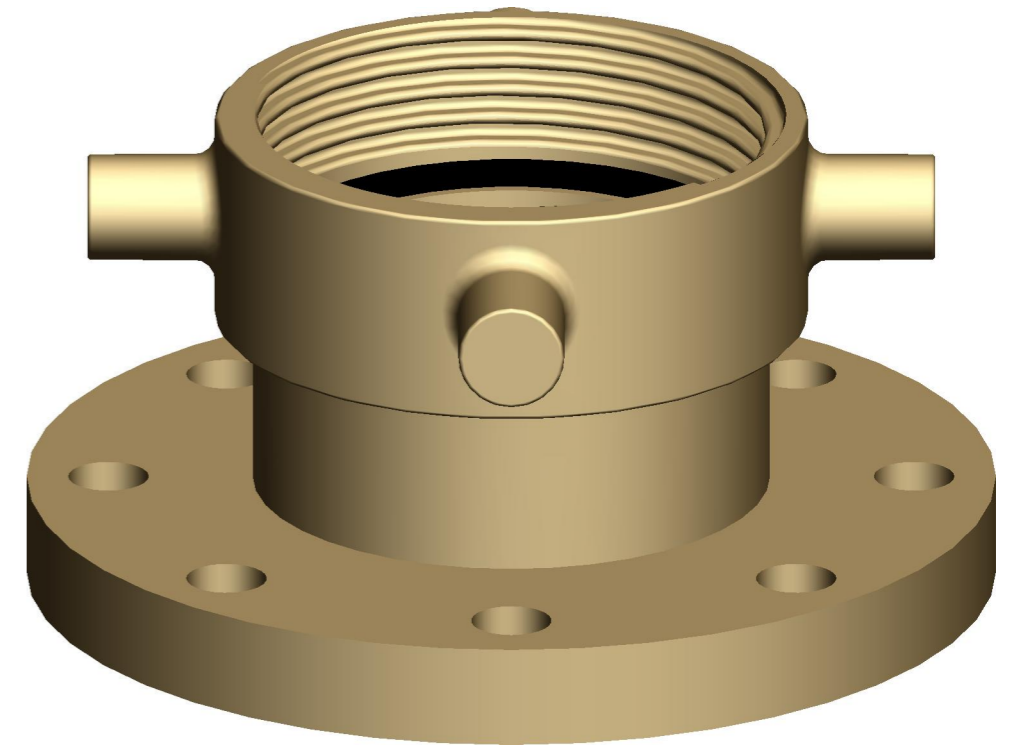
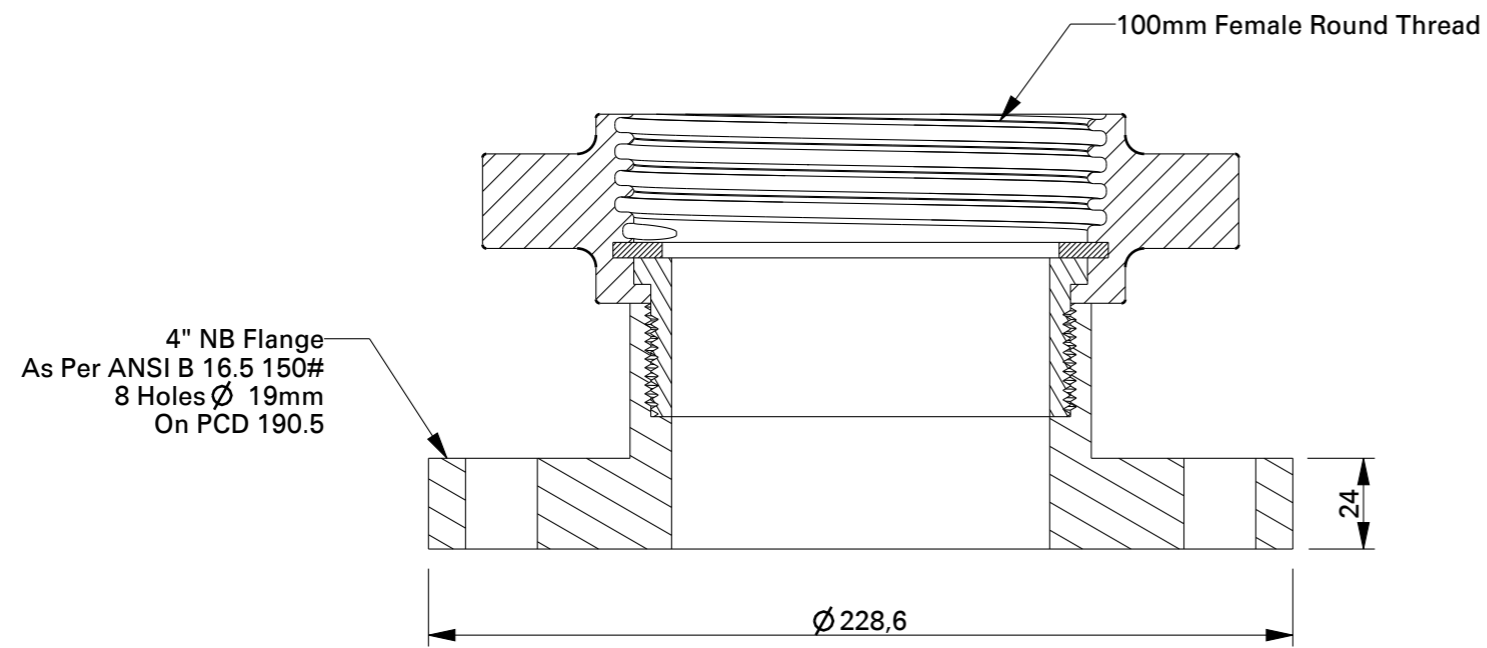

 Shah Bhogilal Jethalal & Bros. AHMEDABAD			
TITLE : Female Round Thread (100mm) x Flanged (100mm) Adaptor, Gunmetal			
SCALE	DRAWING NO:	SHEET	REV.
N.T.S	G176-100BJ	1 OF 1	0