

SUCTION STRAINER

SS304, 75 mm, AS PER IS:907



Suction Strainers are connected to suction hoses when pumping from open water sources such as tanks, ponds or rivers. The Strainer prevents foreign matter, including stones, debris, vegetation, etc from coming into the suction line, and causing damage to the pump and/or firefighting equipment.

Brief Description : AAAG Suction Strainer, 75 mm size, as per IS:907, made of Stainless Steel (SS304), having Female Round Threads of 75 mm size, and suitable for connection with suction hose couplings of similar size threads. Strainer shall have minimum number and size of holes as per IS:907

1.0 GENERAL DATA

1.1	Make	AAAG
1.2	Size	75 mm
1.3	Type	Standard Strainer
1.4	Connection	Female Round Threads 75 mm size
1.5	Material of Construction	Stainless Steel (SS304)
1.6	Reference	IS:907

2.0 MATERIAL OF CONSTRUCTION

2.1	Body	SS304, IS:3444 Grade I
2.2	Strainer Mesh (Sheet)	SS304
2.3	Washer	Rubber, IS:937 Type B

3.0 TESTING AND QUALITY CONTROL

3.1	Dimensional check	See drawing below
3.2	Documentation	Internal inspection report, supplier's certificates, approved laboratory test certificates

4.0 OPERATIONAL/ TECHNICAL DATA

4.1	Working Pressure Range	---
4.2	Weight (approx.)	2.7 Kgs. (approx)

5.0 FINISH

5.1	Strainer	Natural finish/Polished
-----	----------	-------------------------

6.0 APPROVALS & MARKING

6.1	Approvals	--
6.2	Marking	AAAG/ Year of Mfg./SI No

7.0 WARRANTY

7.1	Warranty & Guarantee	12 Months from the date of supply
-----	----------------------	-----------------------------------

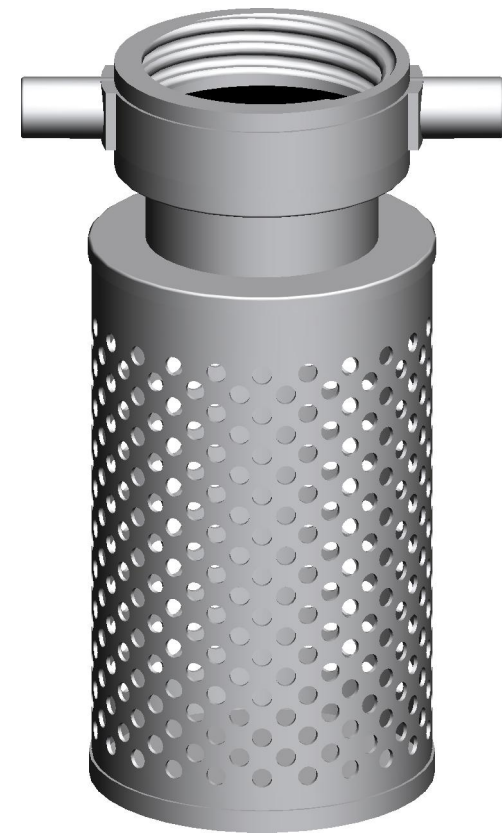
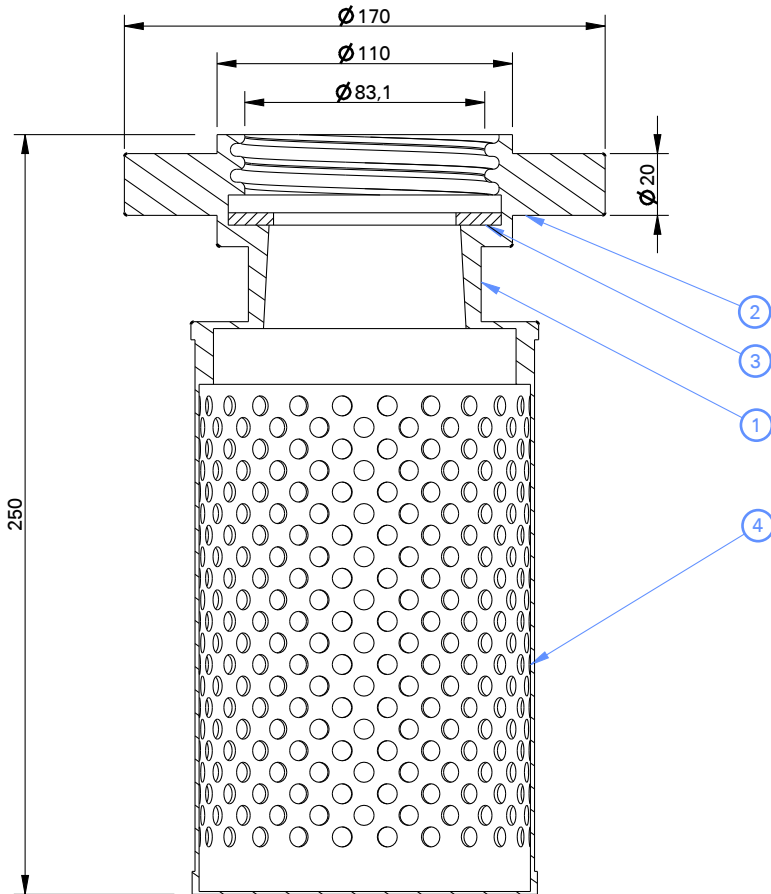

1	Suction Strainer Body	SS 304 (IS: 3444 Gr.1)
2	Nut	SS 304 (IS: 3444 Gr.1)
3	Washer	Rubber IS:937
4	Strainer Jali	SS 304 (IS: 3444 Gr.1)
NO	DESCRIPTION	MATERIAL
PART LIST		



Shah Bhogilal Jethalal & Bros.

AHMEDABAD

TITLE :
Suction Strainer, Round Thread
(75 mm), SS 304, As Per IS: 907

SCALE	DRAWING NO:	SHEET	REV.
N.T.S	S142-75AS	1 OF 1	0