

BLANK CAP (FRT)

SS304, 75 mm



Female Round Thread (FRT) Blank caps are used for covering/ closing pump suction outlets, Water/ Foam storage Tank outlets, etc. The caps are provided with standard Female round threads used in various other Fire Service equipment and fittings.

Brief Description : AAAG Blank Cap (Female Round Threads), made of Stainless Steel (SS304), having standard 75 mm (3") female round threads suitable for use with other standard Fire service fittings/ equipment (Pump outlets, Tank covers, etc) having matching male round threads (threads matching to IS:902)

1.0 GENERAL DATA

1.1	Make	AAAG
1.2	Model	FRT Blank Cap
1.3	Size	75 mm
1.4	Type	Threaded (Female Round Threads - as per IS:902)
1.5	Material of Construction	Stainless Steel (SS304)
1.6	Reference	--

2.0 MATERIAL OF CONSTRUCTION

2.1	Blank Cap	SS304, IS:3444 Grade I
2.2	Washer	Rubber IS:937 Type A

3.0 TESTING AND QUALITY CONTROL

3.1	Dimensional check	See drawing below
3.2	Documentation	Internal inspection report, supplier's certificates, approved laboratory test certificates

4.0 OPERATIONAL/ TECHNICAL DATA

4.1	Working Pressure Range	--
4.2	Weight (approx.)	1.8 Kgs. (approx)

5.0 FINISH

5.1	Blank Cap	Polished
-----	-----------	----------

6.0 APPROVALS & MARKING

6.1	Approvals	--
6.2	Marking	AAAG/ Year of Mfg./SI No

7.0 WARRANTY

7.1	Warranty & Guarantee	12 Months from the date of supply
-----	----------------------	-----------------------------------

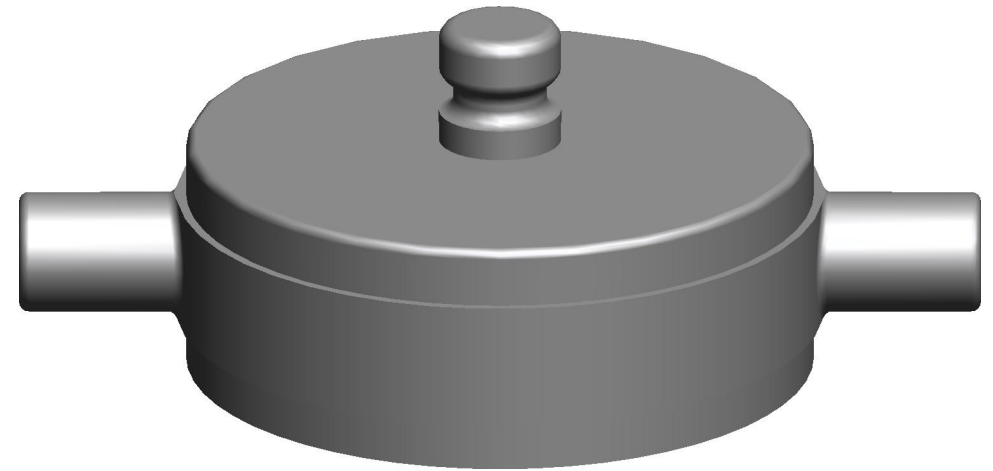
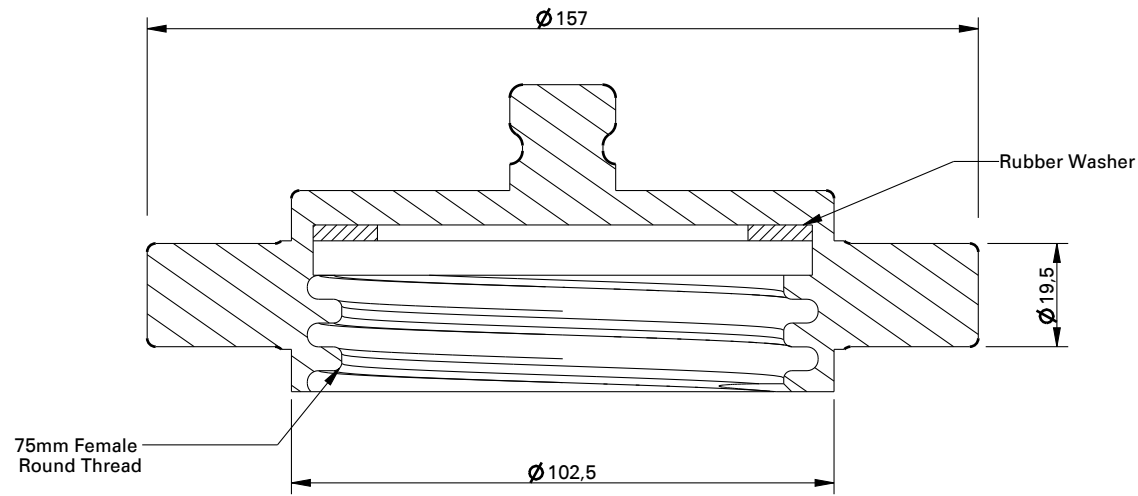

Shah Bhogilal Jethalal & Bros.

AHMEDABAD

TITLE : Blank Cap, Female Round Thread, 75 mm, SS 304, Conventional Design

SCALE	DRAWING NO:	SHEET	REV.
N.T.S	S184-75BJ	1 OF 1	0